



N1020 Temperature Controller

INSTRUCTIONS MANUAL – V1.1x F

INTRODUCTION

The N1020 is a small and yet powerful temperature controller. It accepts most of the temperature sensors used in industry and its 2 outputs can be configured independently as control or alarm output. It also embeds an auto-adaptative PID control algorithm for best system performance.

The configuration can be performed directly on the controller or through the USB interface. The **NConfig** software (free) is the configuration management tool. Connected to the USB of a *Windows* computer, the controller is recognized as a serial communications port (COM) running with a Modbus RTU protocol.

Through the USB interface, even if disconnected from the power supply, the configuration performed in a piece of equipment can be saved in a file and repeated in other pieces of equipment that require the same configuration.

It is important that the users read carefully this manual before using the controller. Verify if the release of this manual matches the instrument version (the firmware version is shown when the controller is energized). The N1020 main characteristics are:

- LED Display, red, high brightness;
- Multi-sensor universal input: : thermocouples, Pt100 and 50 mV;
- Self-tuning PID parameters;
- 2 outputs: 1 relay and 1 logical pulse for SSR;
- Output functions: Control, Alarm1 and Alarm 2;
- 8 distinct alarm functions;
- Programmable timer;
- Function key for enabling/disabling outputs, resetting the timer or turning the timer ON/OFF;
- Programmable *soft-start*;
- Rate function;
- Password for parameters protection;
- Capability of restoring factory calibration.

USB INTERFACE

The USB interface is used for CONFIGURING or MONITORING the controller. The **NConfig** software must be used for the configuration. It makes it possible to create, view, save and open configurations from the equipment or files in your computer. The tool for saving and opening configurations in files makes it possible to transfer configurations between pieces of equipment and to make backup copies. For specific models, the **NConfig** software also makes it possible to update the firmware (internal software) of the controller through the USB.

For MONITORING purposes you can use any supervisory software (SCADA) or laboratory software that supports the MODBUS RTU communication on a serial communications port. When connected to the USB of a computer, the controller is recognized as a conventional serial port (COM x). Use the **NConfig** software or consult the DEVICE MANAGER in the Windows CONTROL PANEL to identify the COM port that was assigned to the controller. Consult the mapping of the MODBUS memory in the controller's communications manual and the documentation of your supervisory software to conduct the MONITORING process.

Follow the procedure below to use the USB communication of the equipment:

1. Download the **NConfig** software from our website and install it on your computer. The USB drivers necessary for operating the communication will be installed together with the software.
2. Connect the USB cable between the equipment and the computer. The controller does not have to be connected to a power supply. The USB will provide enough power to operate the communication (other equipment functions cannot operate).
3. Open the **NConfig** software, configure the communication and start recognition of the device.

	<p>The USB interface IS NOT SEPARATE from the signal input (PV) or the controller's digital inputs and outputs. It is intended for temporary use during CONFIGURATION and MONITORING periods. For the safety of people and equipment, it must only be used when the piece of equipment is completely disconnected from the input/output signals. Using the USB in any other type of connection is possible but requires a careful analysis by the person responsible for installing it. When MONITORING for long periods of time and with connected inputs and outputs, we recommend using the RS485 interface, which is available or optional in most of our products.</p>
--	---

INSTALLATION / CONNECTIONS

The controller must be fastened on a panel, following the sequence of steps described below:

- Prepare a panel cut-out 23 x 46 mm;
- Remove the mounting clamps from the controller;
- Insert the controller into the panel cut-out;
- Slide the mounting clamp from the rear to a firm grip at the panel.

RECOMMENDATIONS FOR THE INSTALLATION

- All electrical connections are made to the screw terminals at the rear of the controller. They accept wire sizes from 0.5 to 1.5 mm² (16 to 22 AWG). The terminals should be tightened to a torque of 0.4 Nm (3.5 lb in).
- To minimize the pick-up of electrical noise, the low voltage DC connections and the sensor input wiring should be routed away from high-current power conductors. If this is impractical, use shielded cables. In general, keep cable lengths to a minimum.
- All electronic instruments must be powered by a clean mains supply, proper for instrumentation.
- It is strongly recommended to apply RC'S FILTERS (noise suppressor) to contactor coils, solenoids, etc.
- In any application it is essential to consider what can happen when any part of the system fails. The controller features by themselves can't assure total protection.

ELECTRICAL CONNECTIONS

The controller complete set of features is drawn in **Fig. 01**. The features loaded in a particular unit are shown on its label:

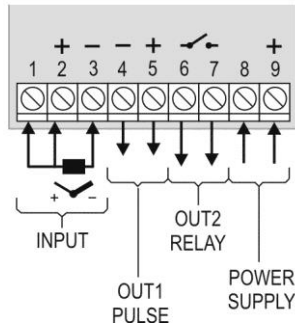

Fig. 01 - Connections of the back panel

Removal of the Controller Back Connector

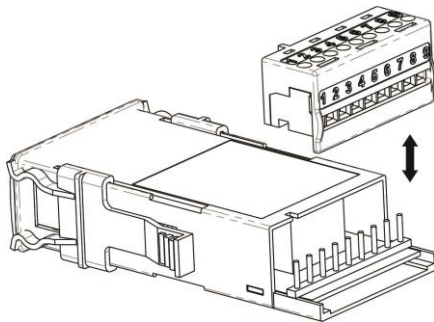

Fig. 02 - Back connector removal

FEATURES

INPUT TYPE SELECTION

Select the input type (in parameter "TYPE") from **Table 01** below.

TYPE	CODE	RANGE OF MEASUREMENT
J	tc J	Range: -110 to 950 °C (-166 to 1742 °F)
K	tc P	Range: -150 to 1370 °C (-238 to 2498 °F)
T	tc t	Range: -160 to 400 °C (-256 to 752 °F)
N	tc n	Range: -270 to 1300 °C (-454 to 2372 °F)
R	tc r	Range: -50 to 1760 °C (-58 to 3200 °F)
S	tc S	Range: -50 to 1760 °C (-58 to 3200 °F)
B	tc b	Range: 400 to 1800 °C (752 to 3272 °F)
E	tc E	Range: -90 to 730 °C (-130 to 1346 °F)
Pt100	Pt	Range: -200 to 850 °C (-328 to 1562 °F)
0 to 50 mV	LQSD	Linear. Programmable indication -1999 to 9999

Table 01 - Input Types

OUTPUTS

The N1020 offers two output channels, user configurable as **Control output**, **Alarm 1 output** or **Alarm 2 output**.

OUT1 - Logical pulse, 5 Vdc / 25 mA, available at terminals 4 and 5.

OUT2 - Relay SPST-NA, 1.5 A / 240 Vac, available at terminals 6 and 7.

Note: The outputs can be configured independently from each other, for example, both can be control outputs at the same time.

CONTROL OUTPUT

The control strategy can be configured as **ON / OFF** or **PID**.

ALARM OUTPUT

There two alarms available in the N1020. The alarms can be assigned to either output, logical or relay. The alarm functions are described below.

ALARM FUNCTIONS

The alarms can be configured to operate with nine different functions, as shown in **Table 02**.

oFF	Alarms turned oFF .
Lo	Alarm of Absolute Minimum Value. Triggers when the value of measured PV is below the value defined for alarm Setpoint (SPA1 or SPA2).
Hi	Alarm of Valor Absolute Maximum Value. Triggers when the value of measured PV is above the value defined for alarm Setpoint.
dIF	Alarm of Differential Value. In this function the parameters SPA1 and SPA2 represent the deviation of PV in relation to the SP of CONTROL .
dIFL	Alarm of Minimum Differential Value. It triggers when the value of PV is below the defined point by (using the Alarm 1 as example):
dIFH	Alarm of Valor Maximum Differential Value. Triggers when the value of PV is above the defined point by (using Alarm 1 as example):
tOn	Timer ON alarm. Sets alarm output ON when timer is running.
tEnd	Timer end. Configures the alarm to actuate when the timer expires.
iErr	Sensor Break Alarm. Activated when the input signal of PV is interrupted, out of the range or when Pt100 in short-circuit.

Table 02 - Alarm functions

Alarms Timer Modes (Temporization)

The controller alarms can be configured to perform 4 timer modes:

MODE	Rt1 R2t1	Rt2 R2t2	ACTION
Normal Operation	0	0	Alarm Output
Activation for a defined time	1 to 6500 s	0	Alarm Output
Activation with delay	0	1 to 6500 s	Alarm Output
Intermittent Activation	1 to 6500 s	1 to 6500 s	Alarm Output

Table 03 - Temporization Functions for the Alarms

The signs associated to the alarms will light when the alarm condition is recognized, not following the actual state of the output, which may be temporarily OFF because of the temporization.

Initial Blocking of Alarm

The initial blocking option inhibits the alarm from being recognized if an alarm condition is present when the controller is first energized (or after a transition from run YES → NO). The alarm will be enabled only after the occurrence of a non alarm condition followed by a new occurrence for the alarm.

The initial blocking is useful, for instance, when one of the alarms is configured as a minimum value alarm, causing the activation of the alarm soon upon the process start-up, an occurrence that may be undesirable.

The initial blocking is disabled for the sensor break alarm function.

RAMP AND SOAK FUNCTION

Allows reaching the SP value gradually. The value of SP is increased gradually from an initial value (PV value) until it reaches the set value. The **rate** parameter sets this increase for SP in **degrees per minute**.

The Ramp function will work when turn on the controller, enable control (RUN = YES) or when the SP value is changed. A value equal to zero (0) in the **rate** parameter disables the Ramp function.

TIMER FUNCTION

The N1020 embeds a timer function (decreasing) for applications that require particular process duration.

Once defined the time interval in the **time** parameter, the timer will START when:

- When PV reaches the temperature programmed in the SP parameter.
- When enabling the control (RUN = YES).
- By pressing the **F** key when configured to Timer reset mode (the timer is reloaded with the **time** parameter and restarts counting).
- By pressing the **F** key in ON/OFF mode stops the timer counting; pressing it again, resumes the counting.

When the timer expires, the two possible actions can be:

- Disables de control (RUN → NO) or
- Activate the alarm.

FUNCTIONS FOR THE F KEY

The **F** key on the frontal keypad is meant for special commands, as follows:

- Enable outputs (identically to the RUN parameter).
- Timer reset: - reloads the timer and initiates a new time counting.
- Timer ON/OFF. Timer holds or resumes counting each time the **F** key is pressed.
Keeping the **F** key pressed for 3 seconds resets the timer (reloads the timer to the value set in **time**), initiating a new time counting.

Note: when the **F** key is configured as RUN = YES/NO (RUN = **FEY**), the controller outputs are born disabled after powers up.

SOFT-START

The Soft-start function is generally used in processes that require slow start-up, where the instantaneous application of 100% of the available power to the load may cause damages to parts of the system.

In order to disable this function, the soft-start parameter must be configured with 0 (zero).

OFFSET

Allows fine trimming the PV indication to compensate for sensor errors. Default value: zero.

SERIAL COMMUNICATION

For full documentation download the **Registers Table N1020 for Serial Communication** on our web site – www.novusautomation.com.

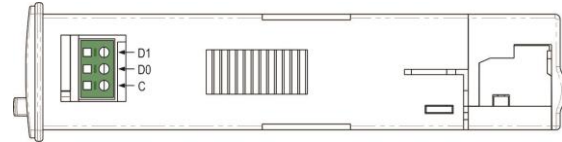

Fig. 03 – Serial Communications Connections

OPERATION

The controller's front panel, with its parts, can be seen in the **Fig. 04**:

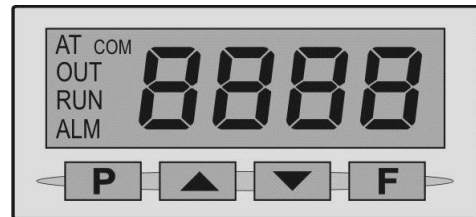

Fig. 04 - Identification of the parts referring to the front panel

Display: Displays the current value of PV. When configuring a parameter, the display alternates between the parameter prompt and its value (the parameter value is shown with a light blinking to differentiate it from the parameter prompt).

The display contains also the signs **AT**, **OUT**, **RUN ALM** and **COM**:

AT Indicator: Stays ON while the controller is in tuning process.

OUT Indicator: For relay or pulse control output; it reflects the actual state of the output.

RUN Indicator: Indicates that the controller is active, with the control output and alarms enabled. (RUN=YES).

ALM Indicator: Signalize the occurrence of alarm condition. It lights when either alarm is active.

COM Indicator: Flashes when there is RS485 activity.

P Key: Used to walk through the menu parameters.

▲ Increment key and ▼ Decrement key: allow altering the values of the parameters.

F Key: accesses special functions: RUN (toggles YES/NO) and the two modes of timer control.

STARTUP

When the controller is powered up, it displays its firmware version for 3 seconds, after which the controller starts normal operation. The value of PV is then displayed and the outputs are enabled.

In order for the controller to operate properly in a process, its parameters need to be configured first, such that it can perform accordingly to the system requirements. The user must be aware of the importance of each parameter and for each one determine a valid condition.

The parameters are grouped in levels according to their functionality and operation easiness. The 5 levels of parameters are:

- 1 – Operation Level
- 2 – Tuning Level
- 3 – Alarms Level
- 4 – Configuration Level
- 5 – Calibration Level

The **P** key is used for accessing the parameters within a level.

Keeping the **P** key pressed, at every 2 seconds the controller jumps to the next level of parameters, showing the first parameter of each level:

PV >> **Atun** >> **FuRI** >> **tYPE** >> **PASS** >> PV ...

To enter a particular level, simply release the **P** key when the first parameter in that level is displayed.

To walk through the parameters in a level, press the **P** key with short strokes.

The display alternates the presentation of the parameter prompt and its value. The parameter value is displayed with a light blinking to differentiate it from the parameter prompt.

Depending on the level of parameter protection adopted, the parameter **PASS** precedes the first parameter in the level where the protection becomes active. See section CONFIGURATION PROTECTION.

At the end of this manual, a table with the complete sequence of levels and parameters is presented.

DESCRIPTION OF THE PARAMETERS

OPERATION LEVEL

PV	PV indication
<i>Timer</i>	Timer remaining time. Only shown when the Timer function is in use. (t h i e ≠ 0) (HH:MM).
SP	Control SP adjustment.
t h i e	Sets the Timer , 00:00 to 99:59 (HH:MM).
r a t e	RATE OF PV RISE: from the current PV to the SP value. In degrees/minute.
r u n	Enables control outputs and alarms. YES - Outputs enabled. no - Outputs disabled. FPEY -"F" key assumes control over the RUN command.

TUNING LEVEL

A t u n <i>Auto-tune</i>	Defines the control strategy to be taken: oFF – Turned off. (no PID tuning) F A S t – Fast automatic tuning. F U L L – More accurate automatic tuning. S E L F – Precise + auto - adaptative tuning r S L F – Forces <u>one</u> new precise automatic precise + auto - adaptative tuning. t G h t - Forces <u>one</u> new precise automatic + auto - adaptative tuning when Run = YES or controller is turned on. Refer to the "DETERMINING PID PARAMETERS" section for further details on tuning strategies.
P b <i>Proportional Band</i>	Proportional Band - Value of the term P of the control mode PID, in percentage of the maximum span of the input type. Adjust of between 0 and 500.0 %. Select zero for ON/OFF control.
I r <i>Integral Rate</i>	Integral Rate - Value of the term I of the PID algorithm, in repetitions per minute (Reset). Adjustable between 0 and 99.99. Displayed only if proportional band ≠ 0.
d t <i>Derivative Time</i>	Derivative Time – Value of the term D of the control mode PID, in seconds. Adjustable between 0 and 300.0 seconds. Displayed only if proportional band ≠ 0.
l t <i>Level Time</i>	Pulse Width Modulation (PWM) period in seconds. Adjustable between 0.5 and 100.0 seconds. Displayed only if proportional band ≠ 0.
H Y S t <i>Hysteresis</i>	Control Hysteresis (in engineering. units): This parameter is only shown for ON / OFF control (Pb=0). Adjustable between 0 and the measurement input type span.
A C t <i>Action</i>	Control Action: For Auto Mode only. r E Control with Reverse Action . Appropriate heating . Turns control output on when PV is below SP. d I r Control with Direct Action . Appropriate for cooling . Turns control output on when PV is above SP.

S F S t <i>Softstart</i>	SoftStart Function –: Time in seconds during which the controller limits the MV value progressively from 0 to 100 %. It is enabled at power up or when the control output is activated. If in doubt set zero (zero value disables the Soft start function).
O U t 1 O U t 2	Outputs 1 and 2 function: oFF not used; C t r L control output. A 1 Alarm 1. A 2 Alarm 2. A I A 2 Alarm 1 AND Alarm 2 at the same time.

ALARMS LEVEL



F u A 1 F u A 2 <i>Function Alarm</i>	Functions of Alarms. Defines the functions for the alarms among the options of the Table 02 .
S P A 1 S P A 2	Alarm Setpoint: Tripping points for alarms 1 and 2. Value that defines the point of activation for the programmed alarms with the functions L o or H i . For the alarms configured with Differential type functions, this parameter defines deviation (band). Not used for the other alarm functions.
b L A 1 b L A 2 <i>Blocking Alarm</i>	Block Alarm 1 and 2: This function blocks the alarms when the controller is energized. YES - enables initial blocking no - inhibits initial blocking
H Y A 1 H Y A 2 <i>Hysteresis of Alarm</i>	Alarm Hysteresis. Defines the difference between the value of PV at which the alarm is triggered and the value at which it is turned off.
A t t 1 A t t 1 <i>Alarm Time t1</i>	Defines the temporization time t1 , for the alarms. In seconds.
A t t 2 A t t 2 <i>Alarm Time t2</i>	Defines the temporization time t2 , for the alarms. In seconds.
F L S h	Allows you to identify the occurrence of alarm conditions by flashing the PV indication on the display screen. YES - Enables alarm signaling flashing PV no - Disables alarm signaling flashing PV

CONFIGURATION LEVEL

t Y P E <i>Type</i>	Input Type: Selects the input signal type to be connected to the process variable input. Refer to Table 1 for the available options.
F L t r <i>Filter</i>	Digital Input Filter - Used to improve the stability of the measured signal (PV). Adjustable between 0 and 20. In 0 (zero) it means filter turned off and 20 means maximum filter. The higher the filter value, the slower is the response of the measured value.
d P P o <i>Decimal Point</i>	Selects the decimal point position to be viewed in both PV and SP.
u n i t <i>Unit</i>	<i>Unit</i> . Temperature indication in °C or °F. Not shown for linear inputs.
O F F s <i>Offset</i>	Sensor Offset: Offset value to be added to the PV reading to compensate sensor error. Default value: zero.
S P L L <i>SP Low Limit</i>	Defines the SP lower limit. To 0-50 mV input type sets the lower range for SP and PV indication.
S P H L <i>SP High Limit</i>	Defines the SP upper limit. To 0-50 mV input type sets the upper range for SP and PV indication.
t h i e <i>Timer</i>	Time . Adjustment. 00:00 to 99:59 (HH:MM). (same function as the one presented in the operation level)

tEn Timer Enable	Shows a copy of the Timer parameter in the operating level. En - enables tEn parameter to the operating level dis - doesn't show the tEn parameter in the operating level
tSt Timer Start	Defines the mode for starting the Timer. SP - when PV reach the temperature value in SP run - when RUN → YES Fst - "F" key (reset timer) FStP - "F" key (start/stop the timer).
tECOff Timer End Control Off	Control behavior when the timer expires: YES - disables the outputs (RUN = NO). no - outputs continue to operate.
rRtE	Ramp function. Establishes the rate of increase of PV, in degrees/minute. Same rRtE function as showed in the operating level.
rEn Rate Enable	Shows a copy of the Rate parameter in the operating level. En - enables the rRtE parameter to the operating level. dis - doesn't show the rRtE parameter in the operating level
run	Enables the control and alarm outputs. YES - outputs enabled. no - outputs disabled. FPEY - outputs enabled/disabled function assigned to the F key. Same run function as showed in the operating level.
ruEn Run Enable	Shows a copy of the run parameter in the operating level. En - enables the run parameter in the operating level dis - doesn't show the run parameter in the operating level
bAud Baud Rate	Baud Rate serial communication. In <i>kbps</i> . 1.2, 2.4, 4.8, 9.6, 19.2, 38.4, 57.6 and 115.2
Prty Parity	Parity of the serial communication. nonE Whitout parity EVE Eve parity Odd Odd parity
Addr Address	Communication Address. Identifies the controller in the network. The possible address numbers are from 1 to 247.

CALIBRATION LEVEL

All of the input and output types are calibrated in the factory. If a recalibration is required, this should be carried out by a experienced personnel. If this level is accidentally accessed, pass through all the parameters without pressing the  or  keys

PASS Password	Input of the Access Password. This parameter is presented before the protected levels. See item Protection of Configuration .
CAL ib Calibration?	Enables or disables instrument calibration by the user, YES: shows calibration parameters No: Hides the calibration parameters
inLC Input Low Calibration	See section MAINTENANCE / Input Calibration. Enter the value corresponding to the low scale signal applied to the analog input. Only showed if CAL ib = YES
inHC Input High Calibration	See section MAINTENANCE / Input Calibration. Enter the value corresponding to the full scale signal applied to the analog input. Only showed if CAL ib = YES
rSt Restore	Restores the factory calibration for all inputs and outputs, disregarding modifications carried out by the user.

ouLL Output Low Limit	Lower limit for the control output - Minimum percentage value assumed by the control output when in automatic mode and in PID. Typically configured with 0 %. Default value: 0 %
ouHL Output High Limit	Upper limit for the control output - Maximum percentage for the control output when in automatic mode and in PID. Typically configured with 100 %. Default value: 100 %.
CJ Cold Junction	Cold junction temperature controller.
PASC Password Change	Allows defining a new access password, always different from zero.
Prot Protection	Sets up the Level of Protection. See Table 04 .
FREQ Frequency	Mains frequency. This parameter is important for proper noise filtering.
SnH	Shows the four first digits of the controller serial number.
SnL	Shows the four last digits of the controller serial number.

CONFIGURATION PROTECTION

The controller provides means for protecting the parameters configurations, not allowing modifications to the parameters values, avoiding tampering or improper manipulation. The parameter **Protection (Prot)**, in the Calibration level, determines the protection strategy, limiting the access to particular levels, as shown by the **Table 04**.

Protection Level	Protection Levels
1	Only the Calibration level is protected.
2	Calibration and Tuning levels.
3	Calibration, Tuning and Alarms levels
4	Calibration, Tuning, Alarms and Configuration levels
5	Calibration, Tuning, Alarms, Configuration levels

Table 04 – Levels of Protection for the Configuration

ACCESS PASSWORD

The protected levels, when accessed, request the user to provide the **Access Password** for granting permission to change the configuration of the parameters on these levels.

The prompt **PASS** precedes the parameters on the protected levels. If no password is entered, the parameters of the protected levels can only be visualized.

The Access Password is defined by the user in the parameter **Password Change (PASC)**, present in the Calibration Level. The factory default for the password code is 1111.

PROTECTION ACCESS PASSWORD

The protection system built into the controller blocks for 10 minutes the access to protected parameters after 5 consecutive frustrated attempts of guessing the correct password.

MASTER PASSWORD

The Master Password is intended for allowing the user to define a new password in the event of it being forgotten. The Master Password doesn't grant access to all parameters, only to the **Password Change** parameter (**PASC**). After defining the new password, the protected parameters may be accessed (and modified) using this new password.

The master password is made up by the last three digits of the serial number of the controller **added** to the number 9000.

As an example, for the equipment with serial number 07154321, the master password is 9 3 2 1.

DETERMINATION OF PID PARAMETERS

The determination (or tuning) of the PID control parameters in the controller can be carried out in an automatic way and auto-adaptive mode. The **automatic tuning** is always initiated under request of the operator, while the **auto-adaptive tuning** is initiated by the controller itself whenever the control performance becomes poor.

Automatic Tuning: In the beginning of the **automatic tuning** the controller has the same behavior of an ON/OFF controller, applying minimum and maximum performance to the process. Along the tuning process the controller's performance is refined until its conclusion, already under optimized PID control. It begins immediately after the selection of the options FAST, FULL, RSLF or TGHT, defined by the operator in the parameter ATUN.

Auto-adaptive Tuning: Is initiated by the controller whenever the control performance is worse than the one found after the previous tuning. In order to activate the performance supervision and **auto-adaptive tuning**, the parameter ATUN must be adjusted for SELF, RSLF or TGHT. The controller's behavior during the **auto-adaptive tuning** will depend on the worsening of the present performance. If the maladjustment is small, the tuning is practically imperceptible for the user. If the maladjustment is big, the **auto-adaptive tuning** is similar to the method of **automatic tuning**, applying minimum and maximum performance to the process in ON/OFF control.

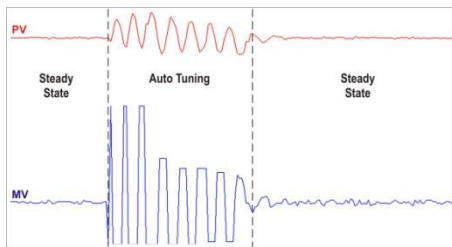

Fig. 05 – Example of auto tuning

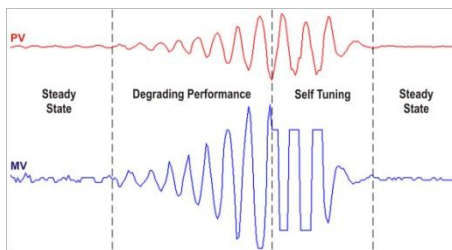

Fig. 06 – Example of auto-adaptive tuning

The operator main select through the ATUN parameter, the desired tuning type among the following options:

- **OFF:** The controller does not carry through **automatic tuning** or **auto-adaptive tuning**. The PID parameters will **not** be automatically determined **nor** optimized by the controller.
- **FAST:** The controller will the process **automatic tuning** one single time, returning to the OFF mode after finishing. The tuning in this mode is completed in less time, but not as precise as in the FULL mode.
- **FULL:** The same as the FAST mode, but the tuning is more precise and slower, resulting in better performance of the P.I.D.
- **SELF:** The performance of the process is monitored and the **auto-adaptive tuning** is automatically initiated by the controller whenever the performance poorer.

After a tuning level, the controller starts collecting data from the process for determining the performance benchmark that will allow evaluate the need for future tunings. This phase is proportional to the process response time and is signaled by the flashing TUNE indication on the display. It is recommended not to turn the controller off neither change the SP during this learning period.

It is recommended not to turn the controller off neither change the SP during this learning period.

- **RSLF:** Accomplishes the **automatic tuning** and returns into the SELF mode. Typically used to force an immediate **automatic tuning** of a controller that was operating in the SELF mode, returning to this mode at the end.
- **TGHT:** Similar to the SELF mode, but in addition **auto-adaptive tuning**, it also executes the **automatic tuning** whenever the controller is set in RUN=YES or when the controller is turned on.

Whenever the parameter ATUN is altered by the operator into a value different from OFF, an automatic tuning is immediately initiated by the controller (if the controller is not in RUN=YES, the tuning will begin when it passes into this condition). The accomplishment of this automatic tuning is essential for the correct operation of the auto-adaptive tuning.

The methods of **automatic tuning** and **auto-adaptive tuning** are appropriate for most of the industrial processes. However, there may be processes or even specific situations where the methods are not capable to determine the controller's parameters in a satisfactory way, resulting in undesired oscillations or even taking the process to extreme conditions. The oscillations themselves imposed by the tuning methods may be intolerable for certain processes.

These possible undesirable effects must be considered before beginning the controller's use, and preventive measures must be adopted in order to assure the integrity of the process and users.

The AT signaling device will stay on during the tuning process.

In the case of PWM or pulse output, the quality of tuning will also depend on the level time adjusted previously by the user.

If the tuning does not result in a satisfactory control, refer to **Table 05** for guidelines on how to correct the behavior of the process.

PARAMETER	VERIFIED PROBLEM	SOLUTION
Proportional Band	Slow answer	Decrease
	Great oscillation	Increase
Rate of Integration	Slow answer	Increase
	Great oscillation	Decrease
Derivative Time	Slow answer or instability	Decrease
	Great oscillation	Increase

Table 05 - Guidance for manual adjustment of the PID parameters

MAINTENANCE

PROBLEMS WITH THE CONTROLLER

Connection errors and inadequate programming are the most common errors found during the controller operation. A final revision may avoid loss of time and damages.

The controller displays some messages to help the user identify problems.

MESSAGE	DESCRIPTION OF THE PROBLEM
----	Open input. No sensor o signal.
Err 1 Err 6	Connection and/or configuration errors. Check the wiring and the configuration.

Other error messages may indicate hardware problems requiring maintenance service.

CALIBRATION OF THE INPUT

All inputs are factory calibrated and recalibration should only be done by qualified personnel. If you are not familiar with these procedures do not attempt to calibrate this instrument.

The calibration steps are:

- Configure the input type to be calibrated.
- Enter in Calibration Level.
- At the input terminals, apply a signal corresponding to a value slightly above the lower input limit.
- Access the parameter **InLc**. Using the \blacktriangle and \blacktriangledown keys, adjust the display reading such as to match the applied signal, then press the **P** key

- At the input terminals, apply a signal corresponding to a value slightly below the upper input limit.
- Access the parameter **InHc**. Using the \blacktriangle and \blacktriangledown keys, adjust the display reading such as to match the applied signal, then press the **P** key.
- Return to the Operation level and check the calibration result.

Note: When checking the controller calibration with a Pt100 simulator, pay attention to the simulator minimum excitation current requirement, which may not be compatible with the 0.170 mA excitation current provided by the controller.

N1020 PARAMETER TABLE

OPERATING LEVEL	TUNING LEVEL	ALARMS LEVEL	CONFIGURATION LEVEL	CALIBRATION LEVEL
PV	Rtun	FuR1	tYPE	PRSS (*)
Timer	Pb	FuR2	FLtr	CRl lb
SP	lr	SPR1	dPPo	InLc
tIIE	dt	SPR2	un l t	InHc
rRE	ct	bLR1	OFFS	rStr
RUN	HYSct	bLR2	SPLL	ouLL
	Rct	HYP1	SPHL	ouHL
	SFSct	HYP2	tIIE	Cl
	OUT1 (pulse)	Rlt1	tEn	PRSc
	OUT2 (relay 1)	R2t1	tStr	Prot
	OUT3 (relay 2)	R2t2	tE.C.O	FrE9
		FLSh	rRE	SnH
			rEn	SnL
			RUN	
			ruEn	
			bAud	
			Prty	
			Addr	

(*) The **PRSS** prompt precedes the parameters on the protected levels.

SPECIFICATIONS

DIMENSIONS:.....25 x 48 x 105 mm (1/16 DIN)

Approximate Weight: 75 g

PANEL CUTOUT:23 x 46 mm (+0.5 -0.0 mm)

POWER SUPPLY:.....100 to 240 Vac/dc ($\pm 10\%$), 50/60 Hz

Maximum consumption:..... 5 VA

CONDITIONS ENVIRONMENTAL:

Operation Temperature: 0 to 50 °C

Relative Humidity:..... 80 % max.

INPUT T/C, Pt100 an voltage (according **Table 01**)

Input Resolution: 32767 levels (15 bits)

Resolution of Display:..... 12000 levels (from -1999 up to 9999)

Rate of input reading:..... up to 55 per second

Precision: ..Thermocouples **J, K, T, E:** 0.25 % of the *span* ± 1 °C

.....Thermocouples **N, R, S, B:** 0.25 % of the *span* ± 3 °C

..... **Pt100:** 0.2 % of the *span*

.....mV: 0.1 %

Input Impedance:Pt100 and thermocouples: > 10 M Ω

Measurement of Pt100: 3-wire type, ($\alpha=0.00385$)

With compensation for cable length, excitation current of 0.170 mA

OUTPUT

OUT1:Voltage pulse; 5 V / 25 mA

OUT2:Relay SPST, 1.5 A / 240 Vac / 30 Vdc

FRONT PANEL:IP65, Polycarbonate (PC) UL94 V-2

ENCLOSURE:IP30, ABS+PC UL94 V-0

ELECTROMAGNETIC COMPATIBILITY:..... EN 61326-1:1997 and EN 61326-1/A1:1998

EMISSION:..... CISPR11/EN55011

IMMUNITY:..... EN61000-4-2, EN61000-4-3, EN61000-4-4, EN61000-4-5, EN61000-4-6, EN61000-4-8 and EN61000-4-11



SAFETY: EN61010-1:1993 and EN61010-1/A2:1995 (UL file E300526)

USB INTERFACE 2.0, CDC CLASS (VIRTUAL COMMUNICATIONS PORT), MODBUS RTU PROTOCOL.

SPECIFIC CONNECTIONS FOR TYPE FORK TERMINALS;

PROGRAMMABLE LEVEL OF PWM DE 0.5 UP 100 SECONDS;

STARTS UP OPERATION AFTER 3 SECONDS CONNECTED TO THE POWER SUPPLY;

CERTIFICATION:  and 

IDENTIFICATION

N1020	- A	- B	- C
-------	-----	-----	-----

A: Output:

PR: OUT1= Pulse / OUT2= Relay

B: Digital Communication:

485: Interface communication RS485

C: Power Supply:

100~240 Vac/dc; 50~60 Hz

SAFETY INFORMATION

Any control system design should take into account that any part of the system has the potential to fail. This product is not a protection or safety device and its alarms are not intended to protect against product failures. Independent safety devices should be always provided if personnel or property are at risk.

Product performance and specifications may be affected by its environment and installation. It's user's responsibility to assure proper grounding, shielding, cable routing and electrical noise filtering, in accordance with local regulations, EMC standards and good installation practices.

SUPPORT AND MAINTENANCE

This product contains no serviceable parts inside. Contact our local distributor in case you need authorized service. For troubleshooting, visit our FAQ at www.novusautomation.com.

LIMITED WARRANTY AND LIMITATION OF LIABILITY

NOVUS warrants to the original purchaser that this product is free from defects in material and workmanship under normal use and service within one (1) year from the date of shipment from factory or from its official sales channel to the original purchaser.



1295 Morningside Ave., Unit 16-18
Scarborough, ON M1B 4Z4 Canada
Phone: 416-261-4865 Fax: 416-261-7879
www.scigiene.com